



Description

Flexy Twin

Modular system which allows you to cover large areas with a minimalist but at the same time very innovative design. An aluminum silver powder coated mast and one or two independently closable and tiltable awnings, provide shade where it is needed. The system allows to connect several Flexy Twin. Ideal for contract (hotels, restaurants...) and residential use (villas, private gardens). The canopy closes easily thanks to a simple pulley system. The Flexy Twin can be supplied with both freestanding or ground insert bases. The structure is made of aluminum with stainless steel hardware. On request the mast can be equipped with lights. All FIM Products are designed and made in Italy using the finest materials for outdoor use, ensuring long life even under the harshest environmental conditions.

Drawings

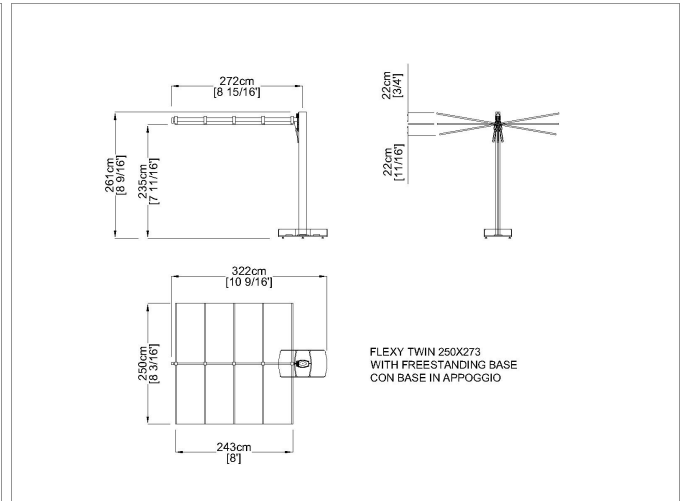
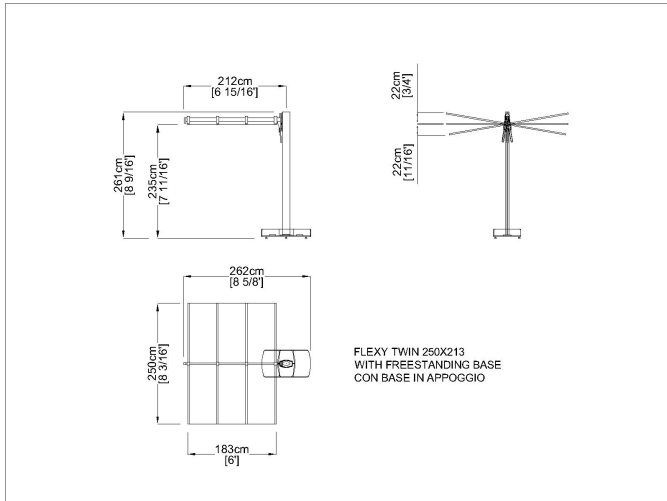

250 x 213

250 x 273

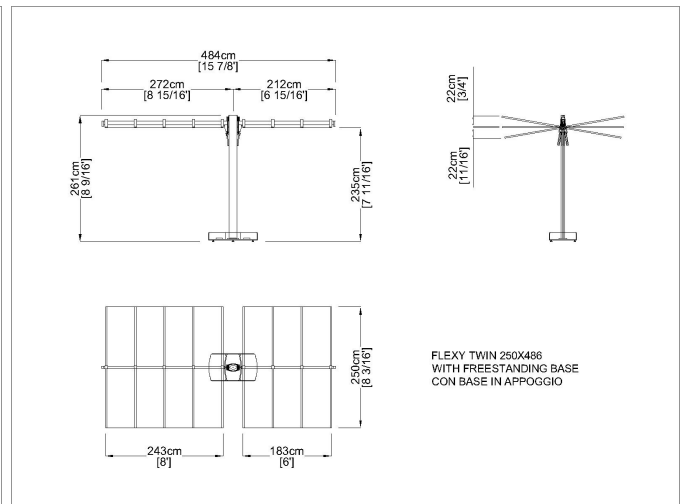
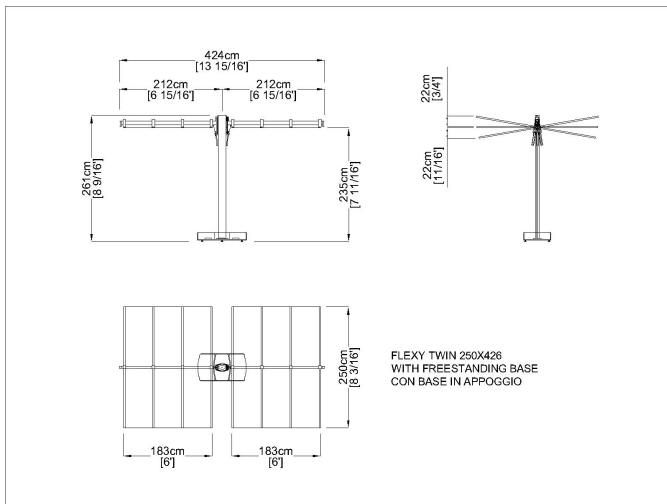

250 x 426

250 x 486

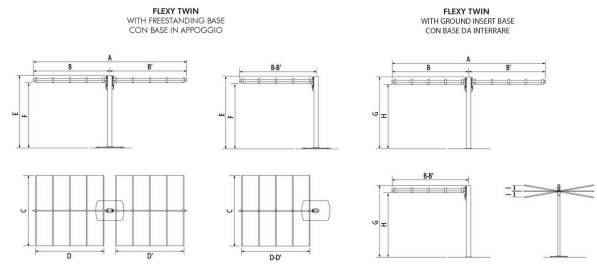
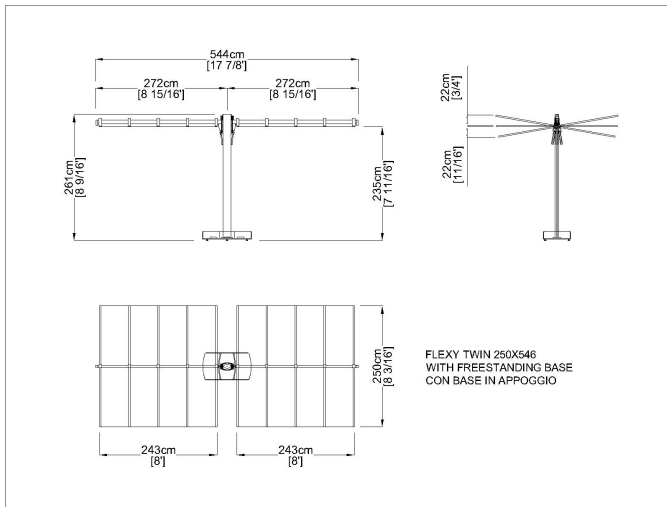

FLEXY TWIN		MEASURE TABLE / TABELLA MISURE									
SIZE / DIMENSIONE (cm)	A	B	B'	C	D	D'	E	F	G	H	I
250x546	544	272	272	250	243	243	261	235	256	230	22
250x486	484	242	242	250	183	183	261	235	256	230	22
250x426	424	212	212	250	183	183	261	235	256	230	22
250x373	373	187	187	250	183	183	261	235	256	230	22
250x313	313	157	157	250	183	183	261	235	256	230	22

250 x 546

Flexy Twin Modular Composition

Materials

Acrylic fabric

Water repellent and stain-resistant acrylic fabric. Available in Ecrù (raw) colour. The ideal fabric, excellent value. 290 gr/m2.

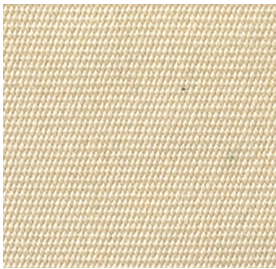

A00 Ecrù
A00

Solution dyed Acrylic Fabric

Designed for outdoor use, the solution (spun) dyed acrylic fabric resists salt water, chlorine and any type of harsh climate. Colours do not bleed and remain vibrant for a long time. A specific treatment makes the fabric water repellent, mould resistant and protects it from staining. This type of fabric resists the most extreme conditions and is suitable for year-round use in gardens, terraces, pool sides or on-board boats. It's definitely the top choice canopy fabric to select for your Product. UPF 50+ (UV Protection Factor) 280 gr/m2.

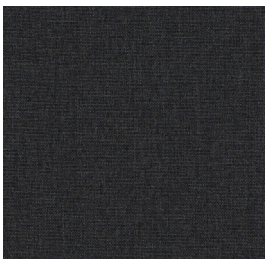

N01 Sooty
10030

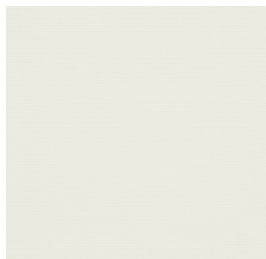

S00 Natural
5404

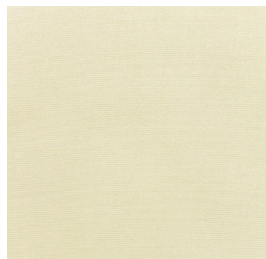

S01 Canvas
5423

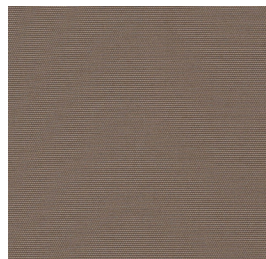

S04 Taupe
3729

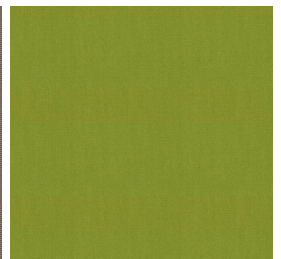

S06 Macao
3738

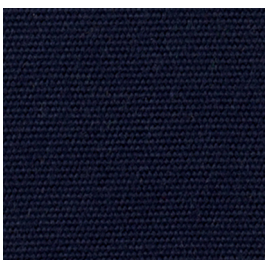

S09 Navy Blue
5439

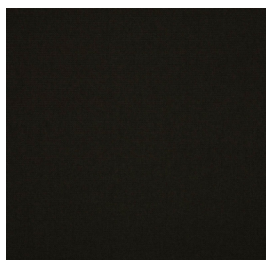

S13 Black
5408

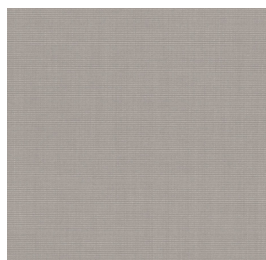

S16 Shingles
3706

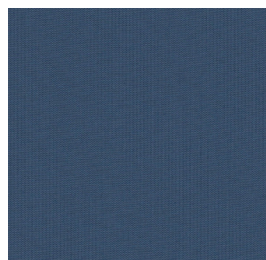

S30 Blue Storm
3942

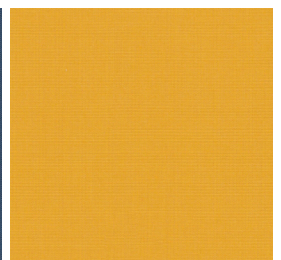

S33 Mimosa
3938

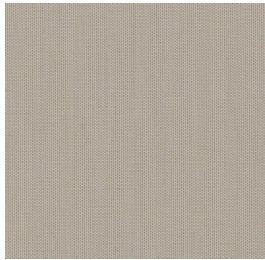

S35 Stone
3988

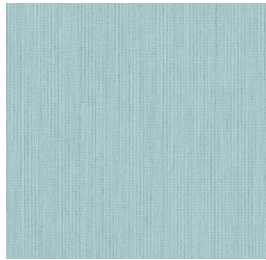

S37 Curacao
3964

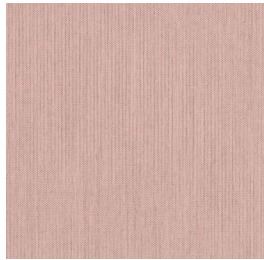

S38 Blush
3965

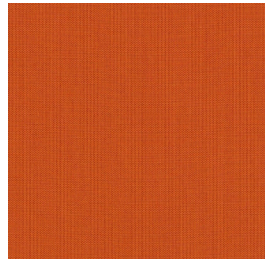

S39 Pumpkin
3969

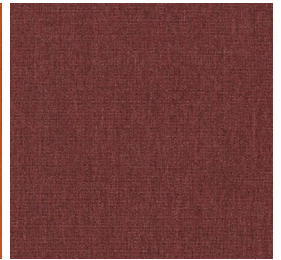

S40 Autumn
3882

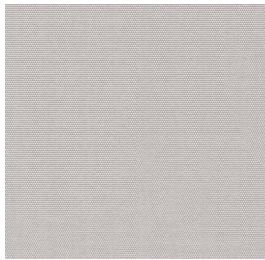

Z02 Silver grey
3741

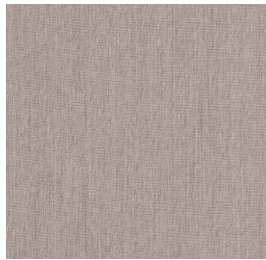

Z03 Lin
3780

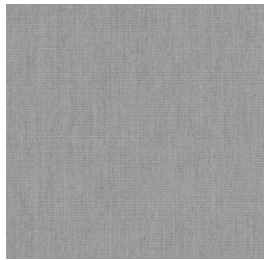

Z09 Lead Chine
3756

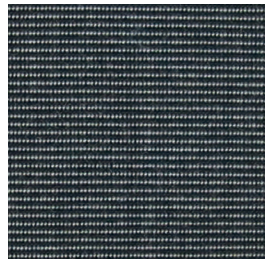

Z14 Charcoal
3705

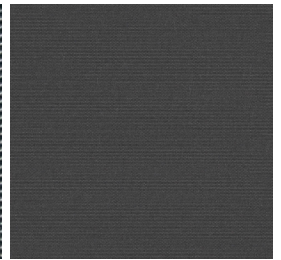

Z15 Carbon
3906

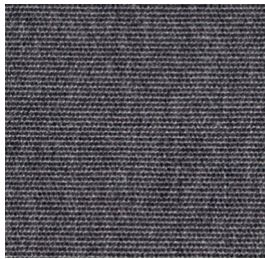

Z18 Flanelle
3757

Solution dyed Acrylic Fabric - Special colours

Designed for outdoor use, the solution (spun) dyed acrylic fabric resists salt water, chlorine and any type of harsh climate. Colours do not bleed and remain vibrant for a long time. A specific treatment makes the fabric water repellent, mould resistant and protects it from staining. This type of fabric resists the most extreme conditions and is suitable for year-round use in gardens, terraces, pool sides or on-board boats. It's definitely the top choice canopy fabric to select for your Product. UPF 50+ (UV Protection Factor) 280 gr/m².

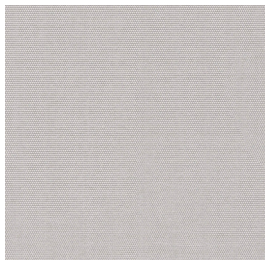

Z02 Silver grey
3741



Z04 Antique Beige
5422



Z05 Arbor Pebble
48009

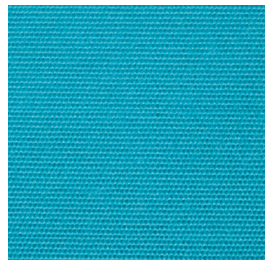

Z06 Aruba
5416

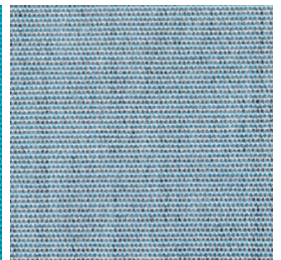

Z08 Mineral Blue Chine
3793

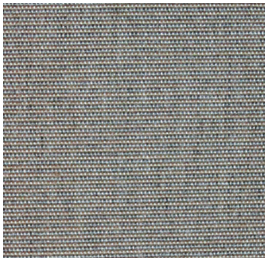

Z10 Taupe Chiné
3907

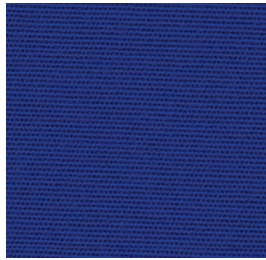

Z11 True Blue
5499

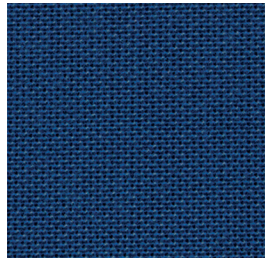

Z12 Riviera Blue
3717

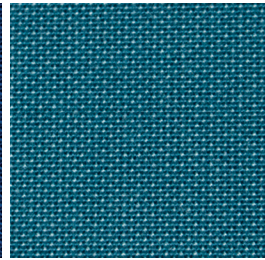

Z13 Adriatic
3941

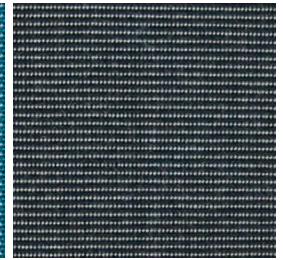

Z14 Charcoal
3705

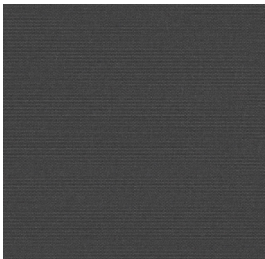

Z15 Carbon
3906

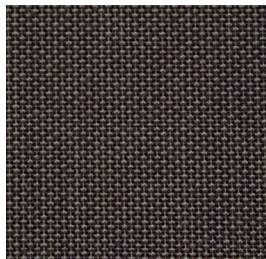

Z17 Mink Brown
3127



Z18 Flanelle
3757



Z19 Dark Smoke
3729



Z20 Sooty
3758

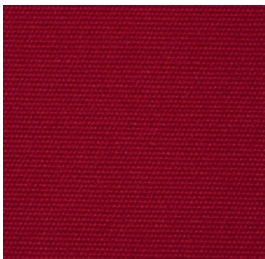

Z23 Paris Red
3728

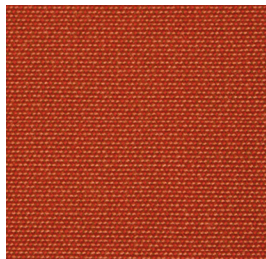

Z30 Paprika
3939

Micro-Mesh fabric

This fabric allows natural air flow and has an excellent resistance to wind, ensuring a pleasant shading at the same time. Suggested to those who want a surely eye-catching alternative fabric. Its fibre composition, taking advantage of the "Precontraint" technology, guarantees an exceptional resistance to tearing, ultraviolet light and mould. 410 gr/m².



M00 Nero
5005

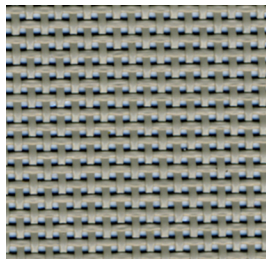

M01 Cenere
5014

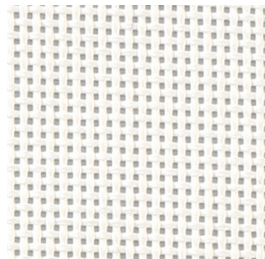

M03 Bianco
5001

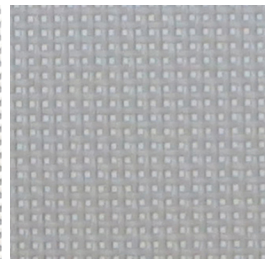

M08 Gris Platine
5374

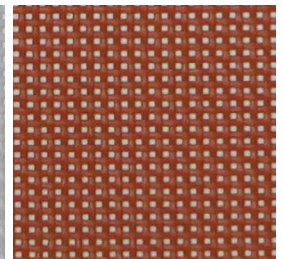

M09 Ambra
5016



Product Sheet

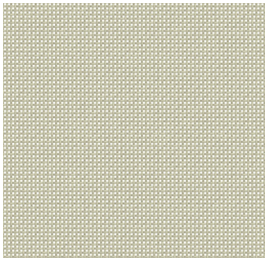

M13 Sage
50880

Airfim Fabric

Waterproof fabric assuring total protection from rain, which does not even permeate the stitches. A stain-resistant treatment contributes toward a better dirt resistance of the fabric, too. A regular wash with a neutral cleaning agent guarantees a long lifespan. UPF 80 (UV Protection Factor) 190 gr/m²

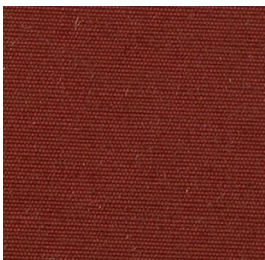

I00 Bordeaux
9879



I01 Ecrù
9833



I02 Verde
9710



I03 Blue
9545

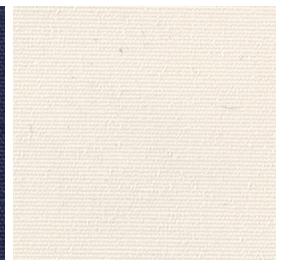

I05 Bianco
9755

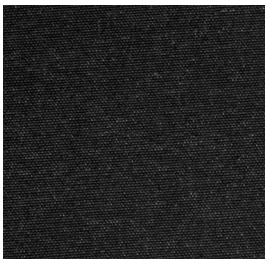

I07 Gray
9654

Finishes

The materials used have been specifically selected and treated to maintain our products durability and consistency over time. The lumber we source is the best available to guarantee structural integrity and strength of the product. Given the fact that wood is a "living" material and reacts to temperature and humidity variations it can consequently show gaps or imperfections that are not to be considered a defect. They do not alter its resistance qualities, but rather witness its continuous vitality. The aluminum profiles are powder coated or anodized to ensure a longer durability in time. The colors may differ from the real ones.



Product Sheet



ANODIC



Product Sheet

Images





Product Sheet

Suggested Products



Flexy

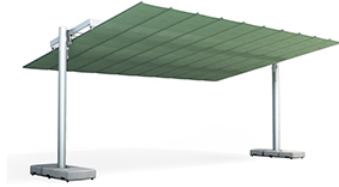

Flexy
Large



Flexy
Zen